



# Microwave antenna UNI3-24

## Antenna description

High Performance  $\varnothing$  0.90 m antenna for ALCOMA point to point radiorelay links with holder for precise horizontal and vertical alignment.

## General parameters

Diameter	0.90 m (3 ft.)
Feeder	dual polarized
Polarization	dual
Input flange: - standard	circular, hole diameter 9.50 mm
Environmental temperature	-35 °C to +55 °C
Color	light grey
Radom material	white plastic canvas

## Electrical parameters

Frequency band	24.000 - 24.250 GHz
Gain: - mid band	44.2 dBi
Beamwidth (-3 dB)	1.0° (H / V)
Return loss	< 1.20 (20.0 dB)
Front to Back Ratio	70 dB
Cross Polarization Discrimination	> 30 dB
Antenna Inter port Isolation	$\geq$ 47 dB
Antenna class	2 (ETSI EN 302 217-4-2)



## UNI3-24

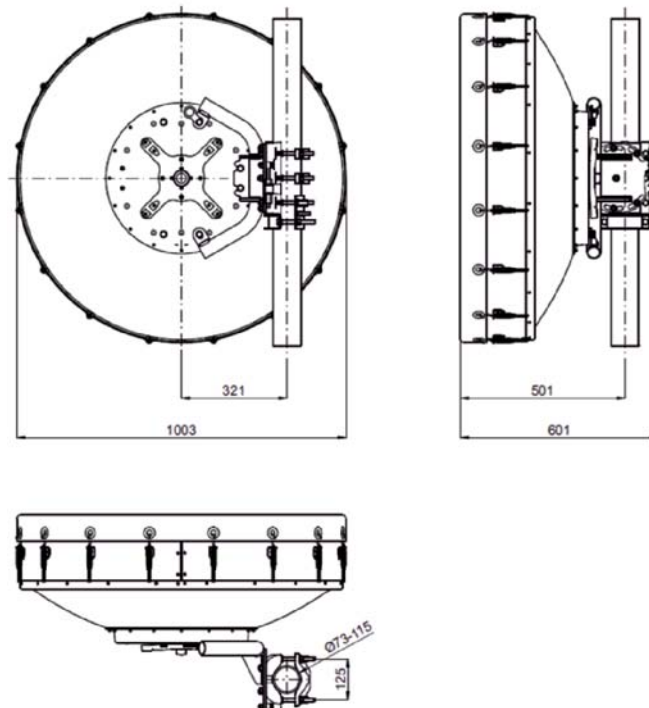

# ALCOMA



# Microwave antenna UNI3-24

## Mechanical parameters due to wind

## UNI3-24

Performance stability	max 30 m/s (110 km/h)
Survival	max 55 m/s (200 km/h)
Radial ice load (density 7kN/m <sup>3</sup> )	25 mm
Net weight (interface A/R)	26.0 kg
Pipe diameter*	73 - 115 mm
Adjust azimuth / elevation	±180° / —
Fine adjust azimuth	±7°
Fine adjust elevation	±15°

## Force and twisting moment due to wind

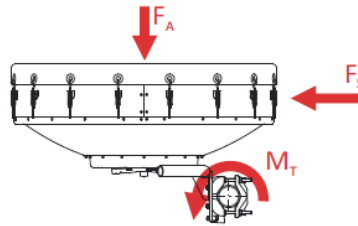

Wind velocity	30 m/s	55 m/s
$F_A$ - axial force	500 N	1850 N
$F_s$ - side force	180 N	570 N
$M_T$ - twisting moment	200 Nm	640 Nm
Icing thickness 25 mm	430 N	